

SERIE / MODEL	EMF-N □□□/B
CODICE / CODE	12.04.□□□.01

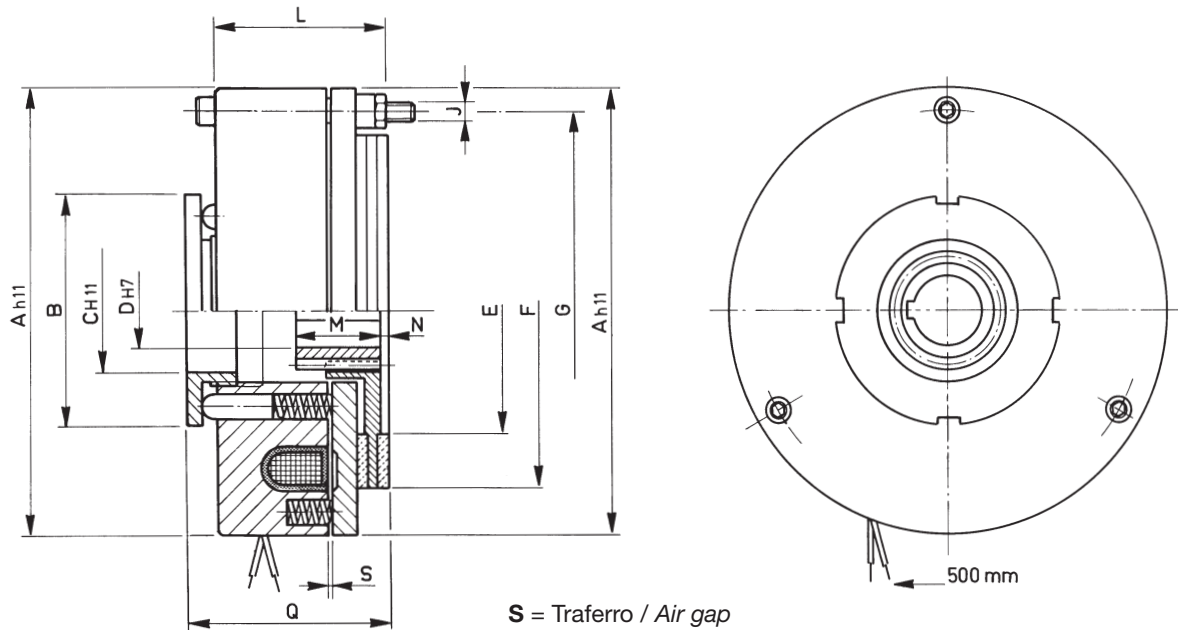

Bobina non eccitata / Coil without excitation energy = Freno bloccato / Locked brake  
Bobina eccitata / Energized coil = Freno libero / Free brake

□□□	Momento Torque Ms (Nm)	Giri/1' R.P.M. limit max.	Tempi inser. Build up time ms.	Tempi disin. Decay time ms.	WATT		Peso Weight kg
					20°	120°	
083	6	6000	55	110	18	13	0,57
100	12	5000	60	130	22	15	1,0
125	25	4000	75	165	30	22	1,3
145	50	3400	88	180	38	27	2,8
160	100	3000	105	200	48	34	3,5
185	140	2600	140	225	54	39	5,9
215	220	2200	200	280	64	46	9,3
250	350	2000	260	310	135	100	15
296	550	1600	340	380	92	68	24,6

□□□	A	B	C	D		E	F	G	J n° x Ø	L	M	N	Q max.	S
				min.	max.									
083	83	42	19	8	12	40	61	72	3 x M 4	31,5	18	—	38	0,2
100	102	52	24	10	15	55	76	90	3 x M 5	35,5	20	—	42	0,2
125	125	63	35	10	24	70	98	112	3 x M 6	44	20	—	52	0,2
145	145	74	40	14	28	76	118	132	3 x M 6	49	25	3	59	0,3
160	160	84	52	14	34	90	129	145	3 x M 8	56	30	3	66	0,3
185	185	98	52	15	38	102	154	170	3 x M 8	59	30	3	70	0,3
215	215	108	62	20	48	120	179	196	6 x M 8	71	35	4,5	84	0,4
250	250	138	73	25	60	150	210	230	6 x M10	78	40	5	100	0,4
296	296	166	95	30	70	195	258	278	6 x M10	88,5	50	6	110	0,5